

**HP**<sup>®</sup>  
**HAMPTON**

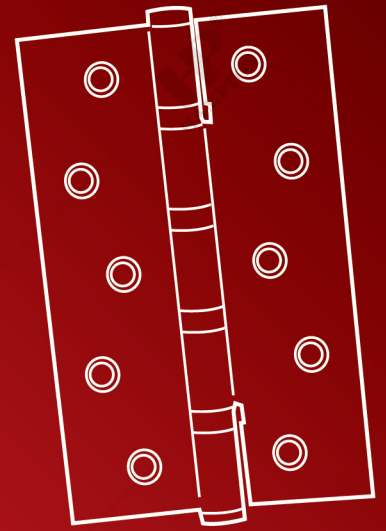

BROCHURE

---

**DOOR &  
WINDOW  
ACCESSORIES**

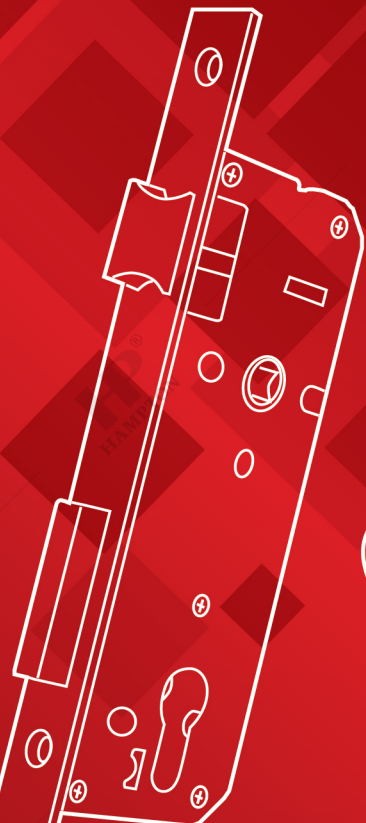

Electronic Lock - <b>ELH 5114 MF FIN PASS BT</b>	<b>1</b>
Hinge	<b>2</b>
Pull Handle	<b>3</b>
Lever Handle Tube Roses	<b>5</b>
Lever Handle Plate	<b>7</b>
Pull Plate	<b>7</b>
Mortise Cylinder	<b>8</b>
Mortise & Cylinder - Ecoline Series	<b>8</b>
Handleset (40x58)	<b>9</b>
Handleset (40x85)	<b>10</b>
Handleset (30x85)	<b>10</b>
Handleset (40x85) Black Series	<b>12</b>
Cylindrical Lockset	<b>14</b>
Padlock	<b>14</b>
Door Closer	<b>14</b>
Door Bolt	<b>15</b>
Flush Bolt	<b>15</b>
Magnetic Door Stopper	<b>16</b>
Door Viewer	<b>16</b>
Door Chain	<b>16</b>
Spring Knip	<b>16</b>
Friction Stay	<b>17</b>
Arm Stay	<b>17</b>
Hanger Hook Wall	<b>18</b>
Window Stay	<b>18</b>
Adjustable Window Holder	<b>18</b>
Aluminium Lock	<b>19</b>
Crescent Lock	<b>19</b>
Casement Handle	<b>19</b>
Mohair	<b>19</b>
Floor Spring	<b>20</b>
Patch Fitting	<b>20</b>
Silicone/Sealant	<b>21</b>
Silicone Gun	<b>22</b>
Shower Hinge	<b>22</b>
Glass Suction	<b>22</b>
Glass Clip	<b>22</b>
Sliding Rail	<b>22</b>
Roller Caster	<b>23</b>
Showcase Roller	<b>23</b>
Spring Support	<b>23</b>
Furniture Handle	<b>23</b>
Furniture Hinge	<b>24</b>
Shower Set (SANITARY)	<b>25</b>
Floor Drain (SANITARY)	<b>25</b>

# TABLE OF CONTENT

**ELECTRONIC LOCK**

# ELH 5114

## MF FIN PASS BT



**ACCESS:**



MOBILE APP



FINGERPRINT



PASSWORD



CARD



MECHANICAL KEY

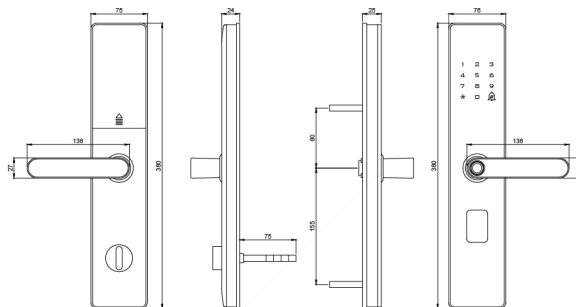

**FEATURES:**



ANTI PEEPING CODE



BATTERY POWER  
AA ALKALINE 4 PCS



UNLOCK HISTORY



DOORBELL



LOW POWER WARNING  
(MTYPE C BACKUP POWER)

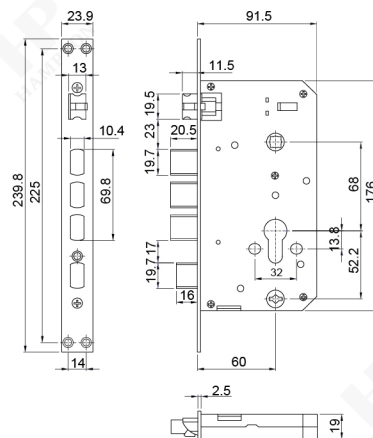

STAINLESS STEEL HINGE



ESS 3x2,5x2MM 2BB SSS



ESS 4x3x2MM 2BB SSS



ESS 4x3x3MM 4BB SSS



ESS 5x3x3MM 4BB SSS



ESS 3x2,5x2MM 2BB  
MATT BLACK



ESS 4x3x2MM 2BB  
MATT BLACK



ESS 4x3x3MM 4BB  
MATT BLACK



ESS 5x3x3MM 4BB  
MATT BLACK

IRON HINGE

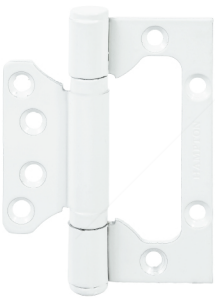

**ONE LEAF HINGE**  
ES IR HPT OL 4x3x2,8MM 2BB  
WHITE



**ONE LEAF HINGE**  
ES IR HPT OL 4x3x2,8MM 2BB  
MATT BLACK



ES IR 3x2,5x2MM 2BB SN



ES IR 3x2,5x2MM 2BB CP



ES IR 3x2,5x2MM 2BB GP



ES IR 4x3x2MM 4BB SN



ES IR 4x3x2MM 4BB CP

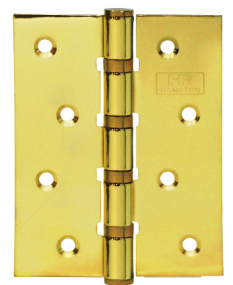

ES IR 4x3x2MM 4BB GP



ES IR 5x3x2,5MM 4BB SN



ES IR 5x3x2,5MM 4BB CP



ES IR 5x3x2,5MM 4BB GP



**PH 003**  
22x15x300x180 SSS+PSS  
Available:  
22x15x400x250 SSS+PSS



**PH 005**  
25x300x180 SSS+PSS  
Available:  
25x400x230 SSS+PSS



**PH 007**  
25x400x250 MATT BLACK  
Available:  
25x300x180 SSS+PSS  
25x400x250 SSS+PSS



**PH 010**  
25x300x180 SSS+PSS  
Available:  
25x400x250 SSS+PSS



**PH 012**  
25x15x300x180 SSS+PSS  
Available:  
25x15x400x250 SSS+PSS



**PH 013**  
25x300x230 SSS+PSS  
Available:  
25x400x280 SSS+PSS



**PH 015**  
25x300x200 SSS+PSS



**PH 017**  
25x300x240 SSS+PSS  
Available:  
25x400x300 SSS+PSS



**PH 018**  
22x22x300x180 PSS+SSS  
Available:  
22x22x400x250 PSS+SSS  
30x15x600x400 MATT BLACK



**PH 021**  
25x300x150 SSS+PSS



**PH 023**  
25x300x150 SSS+PSS  
Available:  
25x400x230 SSS+PSS



**PH SQ501**  
25x25x475x450 MATT BLACK  
Available:  
30x30x630x600 PSS+SSS  
25x25x475x450 PSS+SSS



PH 519  
32x482x450 PSS+SSS

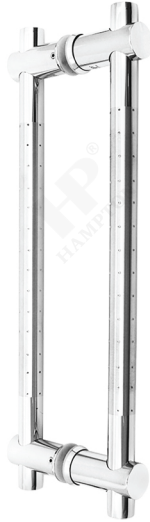

PH 520  
25x450x380 PSS+SSS  
Available:  
32x600x400 PSS+SSS



PH 521  
32x475x450 PSS+SSS  
Available:  
32x475x450 MATT BLACK



PH C 801  
32x382x350 PSS  
Available:  
32x332x300 PSS



PH 801G  
32x382x350 MATT BLACK  
Available:  
32x332x300 MATT BLACK



PH 801G  
32x332x300 WHITE  
Available:  
32x382x350 WHITE



PH 809  
32x382x350 PSS  
Available:  
32x332x300 PSS



PH 813  
25x375x350MM PSS



PH 814  
25x(475 / 175)x(450 / 150) PSS  
Available:  
25x(525 / 225)x(500 / 200) PSS

# LEVER HANDLE TUBE ROSES



LHTR 02-0002 SSS  
Available:  
LHTR 02-0002 MATT BLACK



LHTR 02-0003 19MM SSS  
LHTR 02-0003 22MM SSS



LHTR 02-0006 SSS



LHTR 02-007 SSS  
Available:  
LHTR 02-007 MATT BLACK



LHTR 02-0016 19MM SSS  
LHTR 02-0016 22MM SSS



LHTR 02-019 SSS



LHTR 02-0022 SSS



LHTR 02-0023 SSS



LHTR 02-0024 SSS



LHTR 02-0039 SSS



LHTR 02-0821 SSS



LHTR 02-820 SSS



LHTR 02-104 SSS  
Available:  
LHTR 02-104 MATT BLACK



LHTR 02-0003 OVAL SSS



LHTR 02-0006 OVAL SSS



LHR 02-0039 OVAL SSS



LHR 02-84030 OVAL SSS



LHR 02-820 OVAL SSS



LHR 503 AL GUN METAL  
Available:  
LHR 503 AL MATT BLACK



LHR 505 AL SC  
Available:  
LHR 505 AL GUN METAL  
LHR 505 AL MATT BLACK



LHR 506 AL GUN METAL  
Available:  
LHR 506 AL SC  
LHR 506 AL MATT BLACK



LHR 508 AL MATT BLACK  
Available:  
LHR 508 AL GUN METAL



LHR 520 AL SC  
Available:  
LHR 520 AL GUN METAL  
LHR 520 AL MATT BLACK



LHR 522 AL MATT BLACK  
Available:  
LHR 522 AL SC

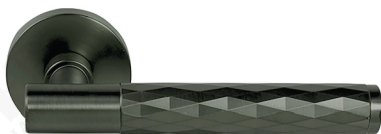

LHR 531 AL GUN METAL  
Available:  
LHR 531 AL CP  
LHR 531 AL MATT BLACK



LHR 535 AL SCM  
Available:  
LHR 535 AL GUN METAL  
LHR 535 AL MATT BLACK

## LEVER HANDLE PLATE



LHP 7301 WH



LHP 7303 WH



LHP 8803 WH



LHP 8803 BK

## PULL PLATE



PP 512 SSS



PP 001 ZA SN



PP 001 ZA AB

**INTERLATCH / SWING**



MTS IL HP485  
SSS



MTS IL HP485  
MATT BLACK

**ROLLER LATCH**



MTS RL HP485  
SSS



MTS RL HP485  
MATT BLACK

**SLIDING**



MTS SLD 4100 40MM  
SSS

**CYLINDER**

**DOUBLE CYLINDER**



CYL DC BR DL 60MM SN



CYL DC BR DL 60MM  
MATT BLACK

**THUMBTURN CYLINDER**



CYL TC BR DL 60MM SN



CYL TC BR DL 60MM  
MATT BLACK

**CYLINDER for LOCKSET**



CYL KC 5123 / 5423

**MORTISE & CYLINDER SET  
ECOLINE SERIES**

**INTERLATCH / SWING**



MTS IL EC3085 + CYL DC 65MM SN

**ROLLER LATCH**



MTS RL EC3085 + CYL DC 65MM KK SN



MTS IL EC4085 + CYL DC 60MM KK SN



MTS IL EC4058 + CYL DC 60MM KK SN



MTS RL EC4085 + CYL DC 60MM KK SN  
Available : MATT BLACK

**HANDLESET (40x58)**



**MTS IL EC4058 + CYL DC 60MM KK SN**



HANDLESET (40X58)  
LHP AI H58321 SN+CP



HANDLESET (40X58)  
LHP AI H58322 SN+CP



HANDLESET (40X58)  
LHP AI H90-5810 SN+CP



HANDLESET (40X58)  
LHP AI H91-5811 SN+CP

**BLACK SERIES**



**MTS IL EC4058 + CYL DC 60MM KK MB**



HANDLESET (40X58)  
LHP AI H58321 MATT BLACK



HANDLESET (40X58)  
LHP AI H58322 MATT BLACK



HANDLESET (40X58)  
LHP AI H90-5810 MATT BLACK



HANDLESET (40X58)  
LHP AI H91-5811 MATT BLACK



**MTS IL EC4085 + CYL DC 60MM KK SN**



HANDLESET (40X85)  
LHP AI HI534 SN+CP



HANDLESET (40X85)  
LHP AI HI536 SN+CP



HANDLESET (40X85)  
LHP AI HI567 SN+CP



HANDLESET (40X85)  
LHP AI HI585 SN+CP



HANDLESET (40X85)  
LHP AI HI55302 SN



HANDLESET (40X85)  
LHP AI HI50502 SN+CP



HANDLESET (40X85)  
LHP AI HI50503 SN+CP



HANDLESET (40X85)  
LHP AI HI50705 SN+CP

# HANDLESET (40x85)



HANDLESET (40X85)  
LHP AI H85326 SN+CP



HANDLESET (40X85)  
LHP AI H85327 SN+CP



HANDLESET (40X85)  
LHP AI H85328 SN+CP

# HANDLESET (30x85)



MTS IL EC3085 + CYL DC 65MM SN



HANDLESET (30X85)  
LHTR 02-84030 SSS



HANDLESET (30X85)  
LHP AI H1514 WHITE



HANDLESET (30X85)  
LHP AI H1514 YBIC



HANDLESET (30X85)  
LHP AI H1514 BLACK

**BLACK SERIES**



**MTS ILEC4085 +  
CYL DC 60MM KK MATT BLACK**



HANDLESET (40X85)  
LHTR 02-0003 MATT BLACK



HANDLESET (40X85)  
LHTR 02-0006 MATT BLACK

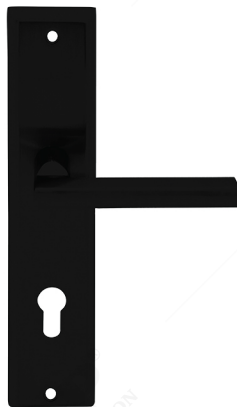

HANDLESET (40X85)  
LHP AI H1228 MATT BLACK



HANDLESET (40X85)  
LHP AI H1567 MATT BLACK



HANDLESET (40X85)  
LHP AI H1585 MATT BLACK



HANDLESET (40X85)  
LHP AI H120502 MATT BLACK

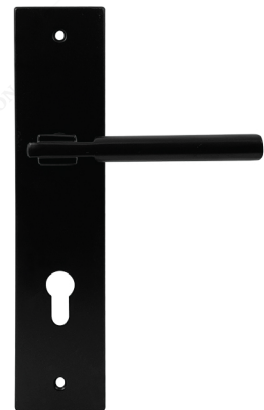

HANDLESET (40X85)  
LHP AI H120503 MATT BLACK

**BLACK SERIES**

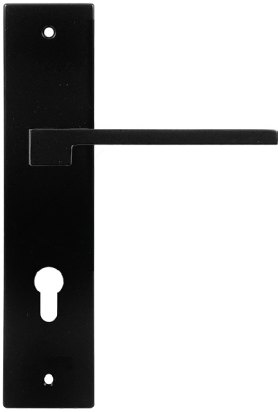

HANDLESET (40X85)  
LHP AI H125302 MATT BLACK



HANDLESET (40X85)  
LHP AI H85326 MATT BLACK



HANDLESET (40X85)  
LHP II H85512 MATT BLACK



HANDLESET (40X85)  
LHP II H85513 MATT BLACK



HANDLESET (40X85)  
LHP II H85515 MATT BLACK

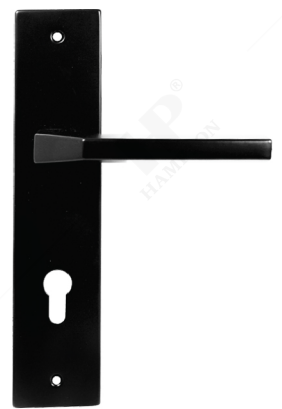

HANDLESET (40X85)  
LHP II H85520 MATT BLACK



HANDLESET (40X85)  
LHP II H85522 MATT BLACK



HANDLESET (40X85)  
LHP II H85523 MATT BLACK

**CYLINDRICAL LOCKSET**



KCBL 5587 ET SSS (For Entrance)



KCBL 5587 BK SSS (For Toilet)

**PADLOCK**



PL H501-40S CP  
Available : • PL H501-50S CP  
• PL H501-60S CP



PL H501-40L CP  
Available : • PL H501-50L CP  
• PL H501-60L CP



PL H536-38S BP  
Available : • PL H536-50S IR BP  
• PL H536-63S IR BP  
• PL H536-75S IR BP



PL H536-38L BP  
Available : • PL H536-50L IR BP  
• PL H536-63L IR BP  
• PL H536-75L IR BP

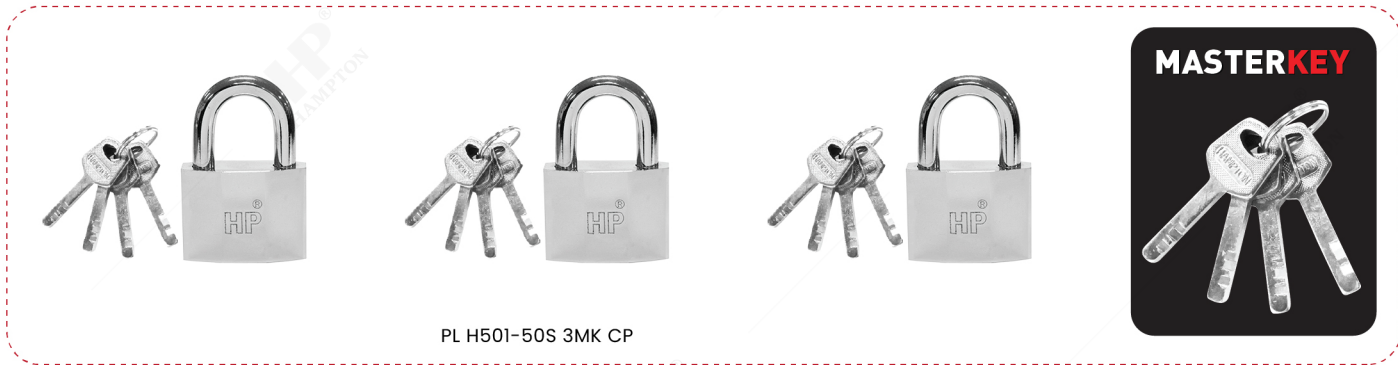

PL H501-50S 3MK CP

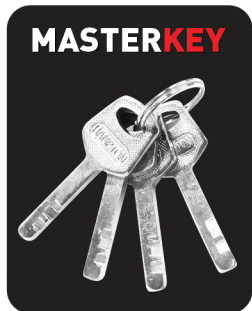

**DOOR CLOSER**

MAX CAPACITY : 40 KG

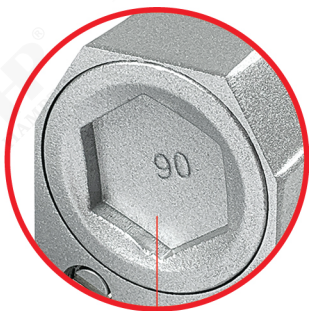

DCL 202 HO NA  
Available : • WH  
• BA



DCL 202 NHO BA  
Available : • NA  
• WH

## DB H01



DB H01 2" SSS



DB H01 3" SSS



DB H01 4" SSS



DB H01 6" SSS



DB H01 12" SSS

## DB AI H03



DB AI H03 2" NA  
Available : WHITE

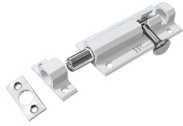

DB AI H03 3" WHITE  
Available : NA



DB AI H03 4" NA



DB AI H03 6" NA



DB AI H03 12" NA



DB AI H03 18" NA



DB AI H03 24" NA  
Available : 36" NA

## BLACK SERIES



DB AI H03 2" MATT BLACK

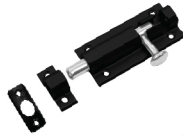

DB AI H03 3" MATT BLACK

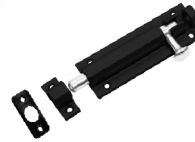

DB AI H03 4" MATT BLACK



DB AI H03 6" MATT BLACK



DB AI H03 12" MATT BLACK



DB AI H03 18" MATT BLACK



DB AI H03 24" MATT BLACK  
Available : 36" MATT BLACK

## DB H021



DB H021 3" SSS

**FLUSH BOLT**



FB 540 8"+12" SSS

**MAGNETIC DOOR STOPPER**



HPT MDS 503 MATT BLACK  
Available : SSS



HPT MDS 2229 SN



HPT MDS 2231 SN

**DOOR CHAIN & DOOR VIEWER**



DOOR CHAIN  
DC 513 SSS



DOOR VIEWER  
DV H20 SN



HPT MDS 2805 SSS



HPT MDS 5183 SSS

**SPRING KNIP**

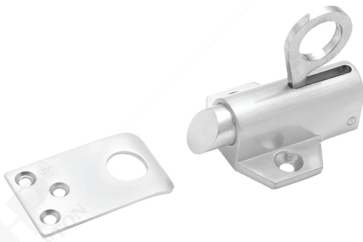

SK 109Z SN  
Available : GP



SK SQ110 SN



SK SQ111 CP



SK SQ112 SSS



SK SQ112 MATT BLACK

# FRICTION STAY

Material : Stainless Steel

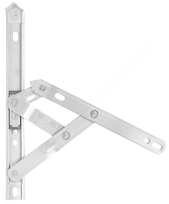

FS 810 8"

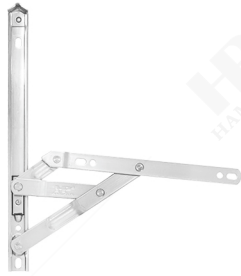

FS 810 10"



FS 810 12"



FS 810 14"



FS 810 16"



FS 810 20"



FS 810 24"

# ARM STAY



AR 12" SSS

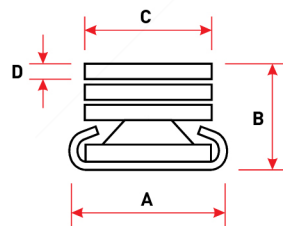

TYPE	A	B	C	D	Max. Vent. Height (mm)	Max. Vent. Width (mm)	Max. Vent. Weight (kg)	Opening Angle (°)	Number of Bar
FS 810 8"	19	14	15.5	2	600	400	6	60°	4
FS 810 10"	19	14	15.5	2	700	500	7	90°	4
FS 810 12"	19	14	15.5	2	900	600	10	90°	4
FS 810 14"	19	16	15.5	2.5	1000	700	13	90°	4
FS 810 16"	19	16	15.5	2.5	1200	800	18	90°	4
FS 810 20"	22	17	18	2.8	1300	800	22	60°	5
FS 810 24"	22	17	18	2.8	1500	800	24	60°	6

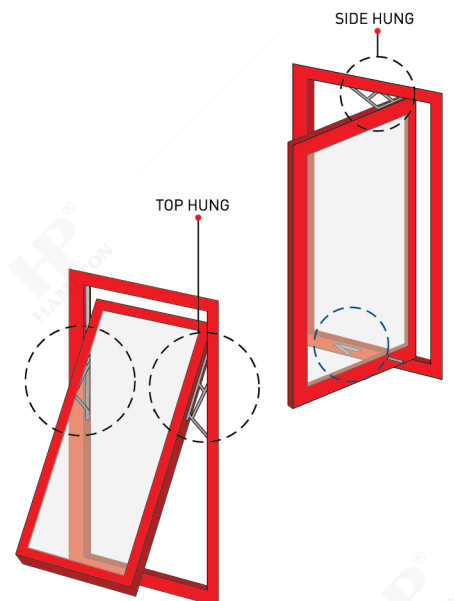

**HANGER HOOK WALL**



HHW AL 003 WHITE



HHW AL 003 GREY



HHW AL 003 MATT BLACK



HHW AL 005 WHITE



HHW AL 005 GREY



HHW AL 005 MATT BLACK



HHW AL 009 WHITE



HHW AL 009 GREY



HHW AL 009 MATT BLACK



HHW ZC 002 CF



HHW ZC 002 MAB



HHW ZC 002 MATT BLACK



HHW ZC 036 CF



HHW ZC 036 GREY

**WINDOW STAY**



WS 511 8" SSS



WS 511 8" HX MATT BLACK  
Available : SSS



WS 512 8" SQ CP



WS 512 8" SQ MATT BLACK

**ADJUSTABLE WINDOW HOLDER**



AWH 402 8" SN



AWH 402 8" MATT BLACK

# ALUMINIUM LOCK



KC HPT 5123



KC HPT 5423



KC HPT 5128 PJ



KC HPT 5128 PD

# CRESCENT LOCK



CL 530 NA



CL 530 BK



CL 530 WH



CL 530 YBIC

# CASEMENT HANDLE



CHW 4 L/H NA  
Available: R/H



CHW 4 R/H WH  
Available: L/H



CHW 4 L/H BK  
Available: R/H



CHW 4 R/H YBIC  
Available: L/H

# MOHAIR



MOHAIR HAMPTON BIG  
MHR 1,1x0,7x175M LIGHT GREY



MOHAIR HAMPTON BIG  
MHR 1,1x0,7x175M BLACK



MOHAIR HAMPTON BIG  
MHR 1,1x0,7x175M BROWN



MOHAIR HAMPTON SMALL  
MHR 0,69x0,5x200M LIGHT GREY



FD 5115 PSS

MOHAIR HAMPTON SMALL  
MHR 0,69x0,5x200M BLACK

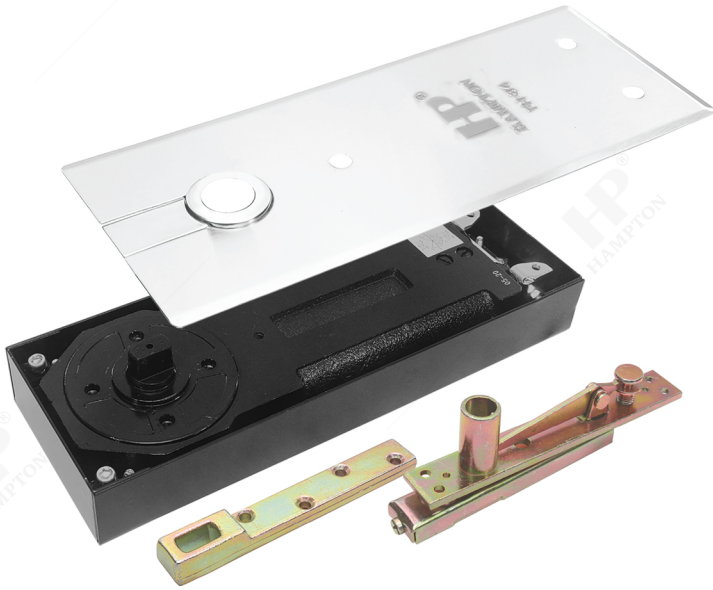

**FH 84 SSS**  
Max Capacity : 80 kg  
Max Door Width : 900 mm



**FH 210 SSS**  
Max Capacity : 60 kg  
Max Door Width : 800 mm

**PATCH FITTING**



PT 10 PSS



PT 20 PSS



PT 30 PSS



PT 40 PSS



US 10 PSS

ILLUSTRATION :

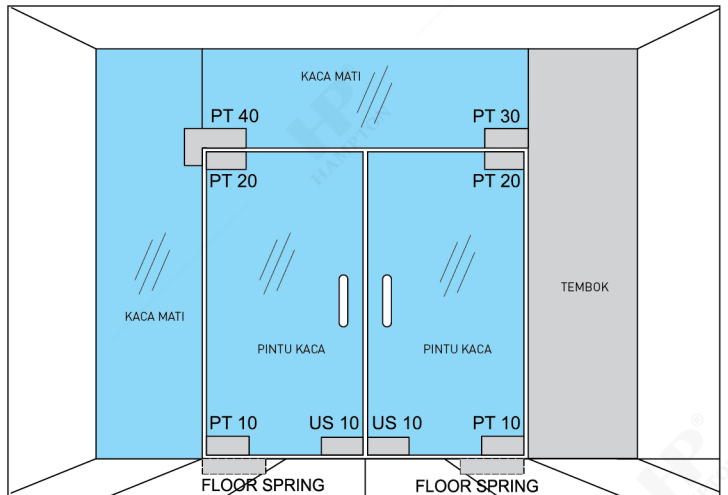

## SILICONE EXTENDED HPT-GP5311

**DESCRIPTION :**

Hampton HPT-GP5311 is an acetic cure general purpose sealant suitable for construction and household repairs. It gives excellent sealing and adhesion to glass, tiles, ceramics fiberglass, aluminium, non-oily woods, plastic and many other non-porous materials.

**APPLICATION :**

Repairing, plumbing, gap-filling and glazing

**COLOURS :**

Clear, Black, Brown, White, Light Grey

**PACKING :**

Silicone HPT GP-5311 is available in 300 ml disposable plastic cartridges.

**STORAGE :**

Store in dry and cool place below 30° C (90° F). Use within 12 months from date of production.

PROPERTY	RESULT
UNCURED-AS TESTED AT 50% RH AND 23°C	
FLOW, SAG OR SLUMP	1 MM MAX
TACK-FREE TIME	10 MINUTES
EXTRUSION RATE	800 ML / MINUTE
CURING SPEED	2-4 MM / DAY
WORKING TIME	5 MINUTES
APPLICATION TEMPERATURE	4°C TO 40°C
CURING TIME	7-14 DAYS
SPECIFIC GRAVITY	0.96 G / CM³
AS CURED-AFTER 21 DAYS AT 50% RH AND 23°C	
DUROMETER HARDNESS, SHORE A	23
ULTIMATE TENSILE STRENGTH	0.60 MPA
ELONGATION AT BREAK	300%
TEMPERATURE RESISTANCE	-30°C TO 90°C



## SILICONE NEUTRAL HPT-5301

**DESCRIPTION :**

HPT-5301 NEUTRAL is a one-component, neutral-curing, low modulus silicone sealant with outstanding adhesion, long shelf life and excellent tooling characteristics for construction, glass and window building. HPT-5301 NEUTRAL cures at room temperature in the presence of atmospheric moisture to give a permanently flexible silicone rubber.

**APPLICATION :**

Neutral sealants are used for a variety of applications, including sealing gaps and joints in a wide range of applications, including in construction, automotive, and industrial settings

**COLOURS :**

Clear, Black, White, Light Grey

**PACKING :**

Silicone HPT GP-5311 is available 300 gr (for clear) and 430gr (for colors) in disposable plastic cartridges.

**STORAGE :**

Store in dry and cool place below 30° C (90° F). Use within 12 months from date of production.

**FOR CLEAR :**

PROPERTY	RESULT
UNCURED-AS TESTED AT 50% RH AND 23°C	
FLOW, SAG OR SLUMP	NO
TACK-FREE TIME	10 MINUTES
EXTRUSION RATE	>250 G / MIN
CURING SPEED	2 MM / 24 H
WORKING TIME	5 MINUTES
APPLICATION TEMPERATURE	4°C TO 60°C
CURING TIME	2-4 MM / 24 H
SPECIFIC GRAVITY	0.98±0.01
AS CURED-AFTER 21 DAYS AT 50% RH AND 23°C	
DUROMETER HARDNESS, SHORE A	30±2
ULTIMATE TENSILE STRENGTH	>0.7 MPA
ELONGATION AT BREAK	>150%
TEMPERATURE RESISTANCE	-50°C TO 200°C

**FOR COLORS :**

PROPERTY	RESULT
UNCURED-AS TESTED AT 50% RH AND 23°C	-
FLOW, SAG OR SLUMP	NO
TACK-FREE TIME	20 MINUTES
EXTRUSION RATE	>300 G / MIN
CURING SPEED	2-4 MM / 24 H
WORKING TIME	10 MINUTES
APPLICATION TEMPERATURE	4°C TO 60°C
CURING TIME	2-4 MM / 24 H
SPECIFIC GRAVITY	1.51±0.02
AS CURED-AFTER 21 DAYS AT 50% RH AND 23°C	
DUROMETER HARDNESS, SHORE A	43±2
ULTIMATE TENSILE STRENGTH	>0.8 MPA
ELONGATION AT BREAK	>200%
TEMPERATURE RESISTANCE	-50°C TO 150°C



**SILICONE GUN**



SILICONE GUN HAMPTON 2000

**SHOWER HINGE**



SH-5801 GW PSS  
Glass Thickness : 8 - 10 mm



SH-5803 GG (180) PSS  
Glass Thickness : 8 - 10 mm

**GLASS SUCTION**



GSC 3S

**GLASS CLIP**



GL H001 (GG) PSS



GL H001 (GW) PSS

**SLIDING RAIL**

TYPE	MAX. CAPACITY
SR H3 1,8M NA	100 Kg
SR H4 2M NA	



BRACKET (4 pcs)



ROLLER (2 pcs)

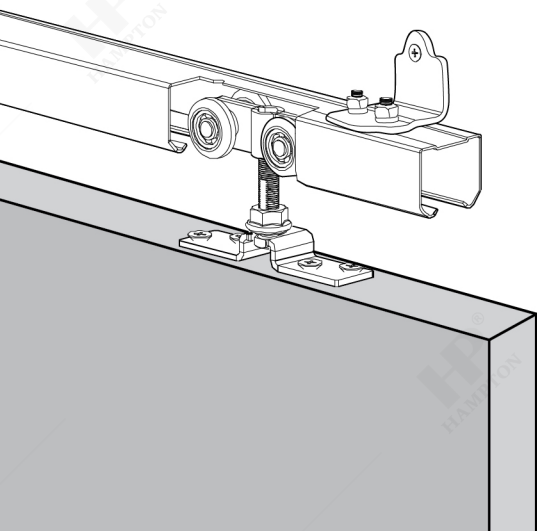

STOPPER (2 pcs)



TRACK 2M  
TRACK 1,8M



FLOOR GUIDE (1 pcs)

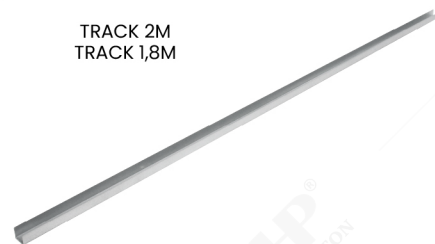

U-CHANNEL 1M

**ROLLER CASTER**



RC 50 2" BALL  
Capacity Max : 50 kg / Pair



RC PP 50 2" BRAKE  
Capacity Max : 30 kg / Pair



RC PP 50 2" NO BRAKE  
Capacity Max : 30 kg / Pair



RC PV 50 2" BRAKE RED  
Capacity Max : 30 kg / Pair  
Available : NO BRAKE



RC PP 75 3" BRAKE  
Capacity Max : 50 kg / Pair



RC PP 75 3" NO BRAKE  
Capacity Max : 50 kg / Pair

**SHOWCASE ROLLER**



SCR H001 BIG CP



SCR H001 SMALL CP

**SPRING SUPPORT**



SP H5213 100N SILVER



SP H5221 SOFT CLOSER 100N SILVER

**FURNITURE HANDLE**



FH H601 12x172MM SSS  
FH H601 12x268MM SSS  
FH H601 12x332MM SSS



FH H602 15x271MM SSS  
FH H602 15x335MM SSS



FH H603 10x20x170MM SSS  
FH H603 10x20x202MM SSS  
FH H603 10x20x266MM SSS  
FH H603 10x20x330MM SSS



FH H605 10x20x170MM SSS  
FH H605 10x20x202MM SSS  
FH H605 10x20x266MM SSS  
FH H605 10x20x330MM SSS



FH H606 14x200MM SSS+PSS  
FH H606 14x264MM SSS+PSS  
FH H606 14x328MM SSS+PSS



FH H607 15x15x136MM SSS+PSS  
FH H607 15x15x168MM SSS+PSS  
FH H607 15x15x200MM SSS+PSS  
FH H607 15x15x264MM SSS+PSS  
FH H607 15x15x328MM SSS+PSS



FH H608 10x10x300MM PSS  
FH H608 10x10x400MM PSS



FH H610 15x15x100MM SSS  
FH H610 15x15x300MM SSS  
FH H610 15x15x400MM SSS  
FH H610 15x15x500MM SSS



HYD ES SD SM501-0  
FULL OVERLAY SN



HYD ES SD SM501-8  
HALF OVERLAY SN



HYD ES SD SM501-16  
INSET SN



ES SD H5261  
FULL OVERLAY CP



ES SD H5261  
HALF OVERLAY CP



ES SD H5261  
INSET CP



HYD ES SD H5103  
FULL OVERLAY CP



ESS SL 5" SSS



ESS SL 9" SSS

# SHOWER SET



- Premium Stainless Steel
- Durable Electroplating
- Dura ABS
- Premium Ceramic Cartridge
- Premium Aerator
- 3 Function
- Hot & Cold Water Mode
- 5 Layer PVC Hose
- Adjustable Holder
- Tangle Guard System

SS 2153-3  
PSS



- Premium Stainless Steel
- Durable Electroplating
- Dura ABS
- Premium Ceramic Cartridge
- Premium Aerator
- 4 Function
- Hot & Cold Water Mode
- 5 Layer PVC Hose
- Adjustable Holder
- Tangle Guard System

SS 2154-4  
PSS

# FLOOR DRAIN



- High Quality Stainless Steel
- Odorless
- Anti Insect
- Heavy Duty Spring System
- Corrosion Resistant
- Flood Resistant



FD 5105 PSS

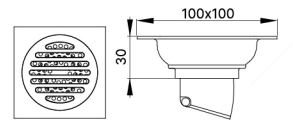

Material : Stainless Steel  
Size : 100x100 mm



FD 5115 PSS

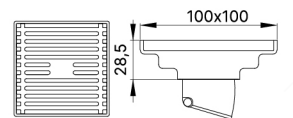

Material : Stainless Steel  
Size : 100x100 mm

**HP<sup>®</sup>**  
**HAMPTON**